











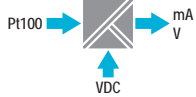
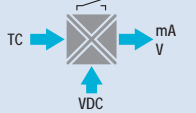
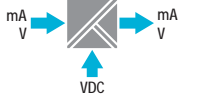
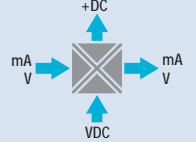

SINEAX
Compact signal converters
6.2 mm ultra slim case

	SINEAX VS30	SINEAX VS40	SINEAX VS46	SINEAX VS50	SINEAX VS52
					
Function	Pt100, Ni100 loop powered converter	Pt100 converter	Thermocouple converter with settable threshold	Galvanic isolator analogue converter	V / I converter with power for 2-wire transducers
Functional diagram					
Order No.	162 769	162 751	162 777	162 785	162 793
General data					
Channels	1 input, 1 output	1 input, 1 output	1 input, 2 outputs	1 input, 1 output	1 input, 1 output
Precision	0.1%	0.1%	0.1%	0.1%	0.1%
Thermal drift	< 100 ppm/K	< 100 ppm/K	< 120 ppm/K	< 120 ppm/K	< 120 ppm/K
LED	<ul style="list-style-type: none"> Fault/alarm Dip-switch error 	Fault/alarm	<ul style="list-style-type: none"> Fault/alarm Alarm setting Static relay output status 	Fault/alarm	Fault/alarm
Power supply	Loop powered (5...30 VDC)	19.2...30 VDC	19.2...30 VDC	19.2...30 VDC	19.2...30 VDC
Isolation	—	1.5 kV (50 Hz, 1min)	1.5 kV (50 Hz, 1min)	1.5 kV (50 Hz, 1min)	1.5 kV (50 Hz, 1min)
Special functions	RTD type/connection, filter, measure range, fault, output inversion and overrange	<ul style="list-style-type: none"> Programmable fault and cut-off Filter 	<ul style="list-style-type: none"> Programmable fault and cut-off Filter Settable rejection 50-60 Hz 	<ul style="list-style-type: none"> Square root extraction Standard tanks linearisation Signal inversion Programmable cut-off Programmable ranges on demand 	<ul style="list-style-type: none"> Square root extraction Standard tanks linearisation Signal inversion Programmable cut-off Auxiliary power supply on 3 terminal blocks 17...20 V, max current 25 mA
Input data					
Type	Pt100 (EN60751/A2-ITS90) <ul style="list-style-type: none"> Range: -200...+650 °C Minimum span: 20 °C Connection technique: 2-, 3-, 4-wire Ni100 <ul style="list-style-type: none"> Range: -60...+250 °C Minimum span: 20 °C Connection: 2-, 3-, 4-wires 	Pt100 <ul style="list-style-type: none"> Pt100 (IEC / EN 60751-ITS90) Range: -150...+650 °C Minimum span: 50 °C Power on transmitter 900 µA Connection: 2-, 3-, 4-wire Max conductor resistance: 20 Ω 	Thermocouple <ul style="list-style-type: none"> Type: J, K, E, N, S, R, B, T (ITS-90 standard) Temperature range: minimum span 100 °C Impedance: 10 MΩ Cold junction 	Voltage <ul style="list-style-type: none"> Range: 0...10 / 2...10 / 0...5 / 1...5 / 0...15 / 0...30 V reversed Impedance: 110 kΩ (10 V), 325 kΩ (30 V) Current <ul style="list-style-type: none"> Range: 0...20 / 4...20 mA Impedance: 35 Ω 	Voltage <ul style="list-style-type: none"> Range: 0...10 / 10...0 / 0...5 / 1...5 V Impedance: 110 kΩ Current <ul style="list-style-type: none"> Range: 0...20 / 4...20 mA Impedance: 35 Ω
Absolute value		Max voltage 32 V	Max voltage 32 V	Max voltage 32 V	Max voltage 32 V
Output data					
Type	Current <ul style="list-style-type: none"> Range: 4...20 / 20...4 mA (2-wire), Load resistance 1 kΩ Resolution 0.5 µA (15 bit + sign) Max current (protection): 30 mA 	Voltage <ul style="list-style-type: none"> Range: 0...10 / 10...0 / 0...5 / 1...5 V Max voltage: overrange 10.25 V, fault 10.5 V, available 12 V Min load resistance: 2 kΩ Current <ul style="list-style-type: none"> Range: 4...20 / 20...4 / 0...20 / 20...0 mA Max current: overrange 20.5 mA, fault 21 mA, protection 25 mA Max load resistance: 500 Ω 	Voltage <ul style="list-style-type: none"> Range: 0...10 / 10...0 / 0...5 / 1...5 V Min load resistance: 2 kΩ Current <ul style="list-style-type: none"> Range: 4...20 / 20...4 / 0...20 / 20...0 mA Max load resistance: 500 Ω 	Voltage <ul style="list-style-type: none"> Range: 0...10 / 2...10 / 0...5 / 1...5 V Min load resistance: 2 kΩ Current <ul style="list-style-type: none"> Range: 4...20 / 20...4 / 0...20 / 20...0 mA Max load resistance: 500 Ω Protection: 25 mA 	Voltage <ul style="list-style-type: none"> Range: 0...10 / 2...10 / 0...5 / 1...5 V Min load resistance: 2 kΩ Current <ul style="list-style-type: none"> Range: 4...20 / 20...4 / 0...20 / 20...0 mA Max load resistance: 500 Ω Protection: 25 mA
Static relay auxiliary output			<ul style="list-style-type: none"> Nominal voltage: 24 V AC/DC Current: 60 mA Overvoltage protection: 50 V Settable alarm trip / hysteresis 		
Response time (10-90%)	< 220 ms (without filter) < 620 ms (with filter)	< 50 ms (without filter) < 200 ms (with filter)	< 40 ms (without filter) < 88 ms (with filter)	< 40 ms (without filter) < 88 ms (with filter)	< 40 ms (without filter) < 88 ms (with filter)
D/A conversion Resolution	1 mV, 2 µA	1 mV, 2 µA	1 mV, 2 µA	1 mV, 2 µA	1 mV, 2 µA

SINEAX VS54	SINEAX VS70
	
Current shunt / V – I converter	Power supply
	
162 800	162 818
1 input, 1 output	2 inputs, 1 output
0.1%	
< 120 ppm/K	
Fault/alarm	<ul style="list-style-type: none"> • Input 1 switch on threshold • Input 2 switch on threshold • Alternate / inverted polarity of inputs
19.2...30 VDC	
1.5 kV (50 Hz, 1 min)	
<ul style="list-style-type: none"> • Programmable fault and cut-off • Filter • Settable rejection 50-60 Hz 	<ul style="list-style-type: none"> • Differential mode filter • Integrated protection against overvoltages • Connection with redundant power supply, to several bus and parallel inputs
Voltage Programmable ranges: from ±25 mV to ±2000 mV	Power supply <ul style="list-style-type: none"> • 2 inputs with shared negative terminal • Pass-through each input can be accessed by 2 pairs of terminals • Positive inputs protected by an external fuse of recommended sizing
Max voltage 32 V	
Voltage <ul style="list-style-type: none"> • Range: 0...10 / 2...10 / 0...5 / 1...5 V • Min load resistance: 2 kΩ 	Power supply Max voltage drop: 300 mV
Current <ul style="list-style-type: none"> • Range: 4...20 / 20...4 / 0...20 / 20...0 mA • Max load resistance: 500 Ω • Protection: 25 mA 	

Technical data	
Power supply range*	19.2...30 VDC
Bridge voltage supply	Bus connectors (CB-Power-Bus) can be snapped onto 35 mm DIN guide rail according to EN 60715
Wire section	0.2...2.5 mm ²
Wire stripping	8 mm
Hot swapping	Yes
Max current consumption	21...25 mA (24 VDC)
Consumption without load at 25 °C	7.5 mA
Max power consumption	500 mW
A/D conversion	14 bit
Rejection	50 or 60 Hz (programmable)
Settings	DIP Switch
Filter	Dumping
Dimensions	93.1 x 6.2 x 102.5 mm
Isolation	1.5 kV (50 Hz, 1 min)
Isolation technique	Digital (optocoupler)
Processing	Floating point 32 bit
Colour	Black
Case material	PBT
Weight	45 g
Operating temperature	-20...+65 °C
Storage temperature	-40...+85 °C
Humidity	10...90 % non condensing
Connection	Clamp terminals and/or bus
Protection degree	IP20

* Except for VS70

Dimensions

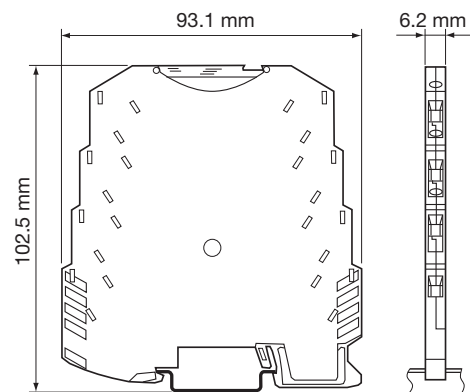

Cage clamp connection

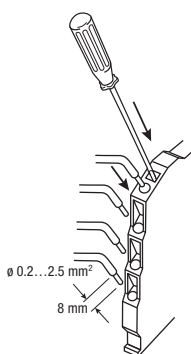

Instruction sequence requires stripping of cables, opening block spring with a screwdriver, inserting the cable into the hole.

CB-Power-Bus

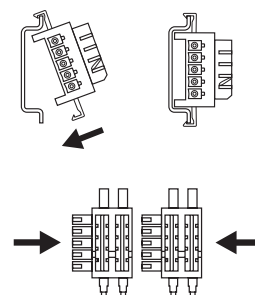

Each expandable connector CB-Power-Bus allows inserting two modules. CB-Power-Bus are inserted on guide setting them to the top and round them at the bottom.

Feature / highlights

Precision

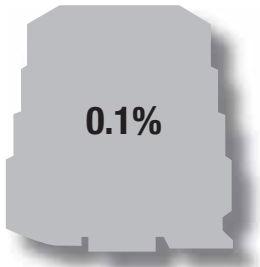

- 0.1 % precision class
- Resolution 14 bit

Configuration

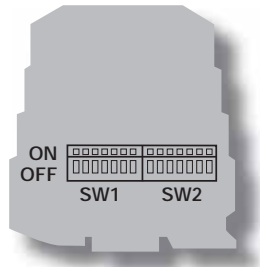

- Setup via DIP switches

Dimensions



- Small dimensions
- 6.2 mm width

Isolation

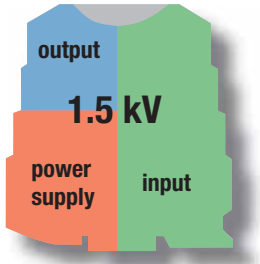

- Digital optocoupler
- 3 way isolation 1.5 kVAC (50 Hz, 1 min)
- Digital decoupling of input signal
- Protection circuit against output overcurrent

Power supply

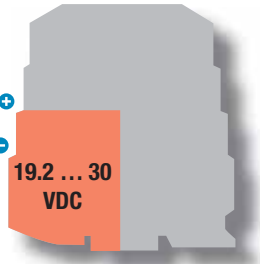

- Direct supply on the spring cage terminal block
- Distributed smart supply by 2 slots CB-Power-Bus and VS70

Connections

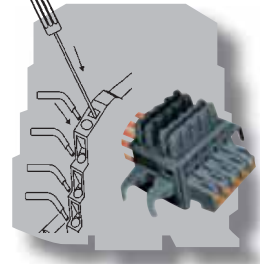

- Cage clamp connectors
- Expandable CB-Power-Bus connector on DIN rail guide

Power supply techniques

The signal conditioners can be powered in 3 different ways: by the spring cage terminal block (24 VDC direct from power supply) or by CB Supply system. CB Supply system is based on expandable CB-Power-Bus connector. Up to 16 devices, the distribution of power supply is possible connecting a single device at voltage source, as whole consumption doesn't exceed 400 mA. Over 16 and up to 75 devices, with maximum current consumption of 1.6 A (approx. 21 mA per module), a VS70 module is needed.

Conventional supply

Power supply on spring-cage terminals

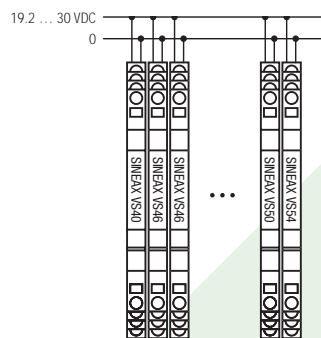

Smart supply system

Distributed supply with 2 slot connector CB-Power-Bus (up to 16 modules)

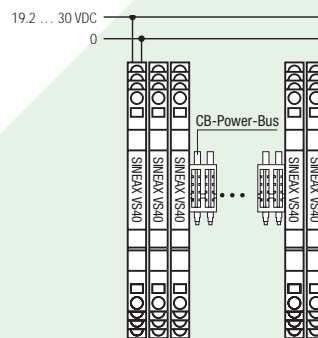

Distributed supply with VS70 module and CB-Power-Bus (up to 75 modules)

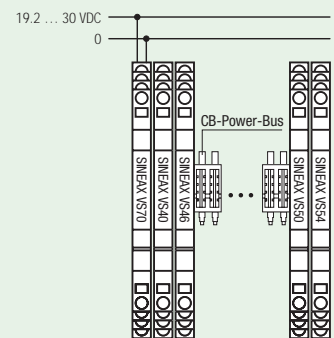

CAMILLE BAUER

Rely on us.

Camille Bauer AG
Aargauerstrasse 7
CH-5610 Wohlen / Switzerland
Phone +41 56 618 21 11
Fax +41 56 618 35 35
info@camillebauer.com
www.camillebauer.com